



MODEL NO. : TM056KDH01

ISSUED DATE: 2008-11-19

VERSION : Ver 2.1

- Preliminary Specification
- Final Product Specification

Customer : _____

Approved by	Notes

SHANGHAI TIANMA Confirmed :

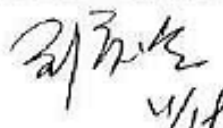
Prepared by	Checked by	Approved by
陈艳光 2008.11.19	 28.11.19	 4/19

This technical specification is subjected to change without notice

The information contained herein is the exclusive property of SHANGHAI TIANMA MICRO-ELECTRONICS Corporation, and shall not be distributed, reproduced, or disclosed in whole or in part without prior written permission of SHANGHAI TIANMA MICRO-ELECTRONICS Corporation.



Table of Contents

Coversheet.....	1
Table of Contents	2
Record of Revision.....	3
1 General Specifications	4
2 Input/Output Terminals	5
3 Absolute Maximum Ratings	7
4 Electrical Characteristics.....	8
5 Timing Chart.....	10
6 Optical Characteristics	15
7 Environmental / Reliability Test	19
8 Mechanical Drawing.....	20
9 Packing Drawing	21
10 Precautions for Use of LCD Modules.....	23



1 General Specifications

Feature		Spec
Display Spec.	Size	5.6 inch
	Resolution	320(RGB) x 234
	Interface	Analog RGB
	Color Depth	Full color
	Technology Type	a-Si TFT
	Dot Pitch (mm)	0.118 x 0.362
	Pixel Configuration	R.G.B. Vertical Stripe
	Display Mode	TM with Normally White
	Surface Treatment(Up Polarizer)	Anti-Glare
	Viewing Direction	12 o'clock
	Gray Scale Inversion Direction	6 o'clock
Mechanical Characteristics	LCM (W x H x D) (mm)	126.50 x 100.00 x 5.70
	Active Area(mm)	113.280 x 84.708
	With /Without TSP	Without TSP
	Weight (gram)	123.0
	LED number	14 LEDs

Note 1 : Viewing direction for best image quality is different from TFT definition, there is a 180 degree shift.

Note 2 : Requirements on Environmental Protection: RoHS

Note 3: The weight tolerance: $\pm 5\%$.



2 Input/Output Terminals

2.1 TFT LCD panel driving section

FPC Connect type is : FH12-26S-0.5SH

No	Symbol	I/O	Description	Remark
1	GND	P	Ground	
2	VCC	P	Supply voltage for scan driver	
3	VGL	P	Negative power for scan driver	
4	VGH	P	Positive power for scan driver	
5	STVD	I/O	Vertical start pulse down side	Note 1
6	STVU	I/O	Vertical start pulse up side	Note 1
7	CKV	I	Shift clock input	
8	U/D	I	UP/DOWN scan control input	Note 1
9	OEV	I	Output enable control for scan	
10	VCOM	I	Common electrode driving signal	
11	VCOM	I	Common electrode driving signal	
12	L/R	I	LEFT/RIGHT scan control input	Note 1
13	MOD	I	Sequential sampling and simultaneous sampling setting	Note 2
14	OEH	I	Output enable control for data driver	
15	STHL	I/O	Start pulse for horizontal scan line left side	Note 1
16	STHR	I/O	Start pulse for horizontal scan line right side	Note 1
17	CPH3	I	Sampling and shifting clock pulse for data driver	Note 2
18	CPH2	I	Sampling and shifting clock pulse for data driver	Note 2
19	CPH1	I	Sampling and shifting clock pulse for data driver	Note 2
20	VCC	P	Supply voltage for data driver	
21	GND	P	Ground	
22	VR	I	Alternated video signal(Red)	
23	VG	I	Alternated video signal(Green)	
24	VB	I	Alternated video signal(Blue)	
25	AVDD	P	Supply voltage for analog circuit	
26	AVSS	P	Ground for analog circuit	

Table 2.1 input terminal pin assignment

I: input pin; I/O: input/output pin; P: Power/GND;

Note 1: select of scanning mode

Setting of scan control input		In/out state for start pulse				Scanning direction
U/D	L/R	STVD	STVU	STHR	STHL	
GND	VCC	0	1	0	1	Up to down, left to right
VCC	GND	1	0	1	0	Down to up, right to left
GND	GND	0	1	1	0	Up to down, right to left
VCC	VCC	1	0	0	1	Down to up, left to right



Refer to the figure as below

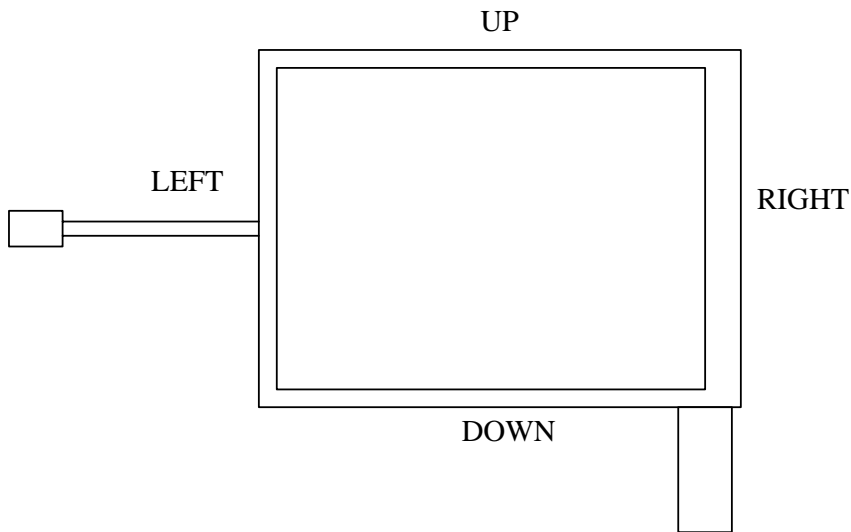

Note 2: MOD=H, simultaneous sampling.
MOD=L, sequential sampling.
Please set CPH2 and CPH3 to GND when MOD=H.

2.2 Backlight unit section

Pin No.	Symbol	I/O	Function	Remark
1	HI	P	Power supply for backlight unit	Pink line
2	GND	P	Ground for backlight unit	White line



3 Absolute Maximum Ratings

GND=0V, Ta = 25°C

Item	Symbol	Min	Max	Unit	Remark
Power Voltage	VCC	-0.3	7.0	V	
	AVDD	-0.3	7.0	V	
	VGH	-0.3	18.0	V	
	VGL	-15.0	0.3	V	
	VGH-VGL	-	33.0	V	
Input signal voltage	V _A	-0.2	AVDD+0.2	V	Note 1
	V _L	-0.3	AVDD+0.3	V	Note 2
Operating Temperature	Top	-20	70	°C	
Storage Temperature	Tst	-30	80	°C	

Table 3.1 Absolute maximum rating

Note 1: VR, VG, VB

Note 2: STHL, STHR, OEH, L/R, CPH1-3, STVU, STVD, OEV, CKV, U/D



4 Electrical Characteristics

4.1 LCD module

GND=0V, Ta=25°C

Item	Symbol	Min	Typ	Max	Unit	Remark	
Logic supply voltage	VCC	4.8	5.0	5.2	V		
Analog supply voltage	AVDD	4.8	5.0	5.2	V		
Negative power for scan driver	VGL	-10.5	-10.0	-9.5	V		
Positive power for scan driver	VGH	14.3	15.0	15.7	V		
Input Signal Voltage	Low Level	V_{IL}	0	-	0.2xVCC	V	Note 1
	High Level	V_{IH}	0.8xVCC	-	VCC	V	
Output Signal Voltage	Low Level	V_{OL}	0	-	0.2xVCC	V	
	High Level	V_{OH}	0.8xVCC	-	VCC	V	
Video Signal Amplitude	V_{IA}	0.2	-	AVDD-0.2	V		
	V_{IAC}	-	3.5	-	V		
	V_{IDC}	-	AVDD/2	-	V		
VCOM	V_{CAC}	-	5.4	-	V		
	V_{CDC}	1.55	-	1.95	V		
Power Consumption	I_{VCC}	-	0.80	1.2	mA	Note 2	
	I_{AVDD}	-	3.41	5.12	mA		
	I_{VGH}	-	0.056	0.084	mA		
	I_{VGL}	-	0.056	0.084	mA		

Table 4.1 LCD module electrical characteristics

Note 1: STHL, STHR, OEH, L/R, CPH1-3, STVU, STVD, OEV, CKV, U/D

Note 2: Test condition: Voltage fix on: VCC=5.0V, AVDD=5.0V, VGH=15.0V, VGL=-10V

4.2 Backlight Unit

Ta=25°C

Item	Symbol	Min	Typ	Max	Unit	Remark
Forward Current	I_F	-	140	-	mA	Note 1
Forward Current Voltage	V_F	-	6.4	-	V	
Backlight Power Consumption	W_{BL}	-	896	-	mW	

Table 4.2 Backlight unit electrical characteristics

Note1: For each LED, $I_L=20mA$

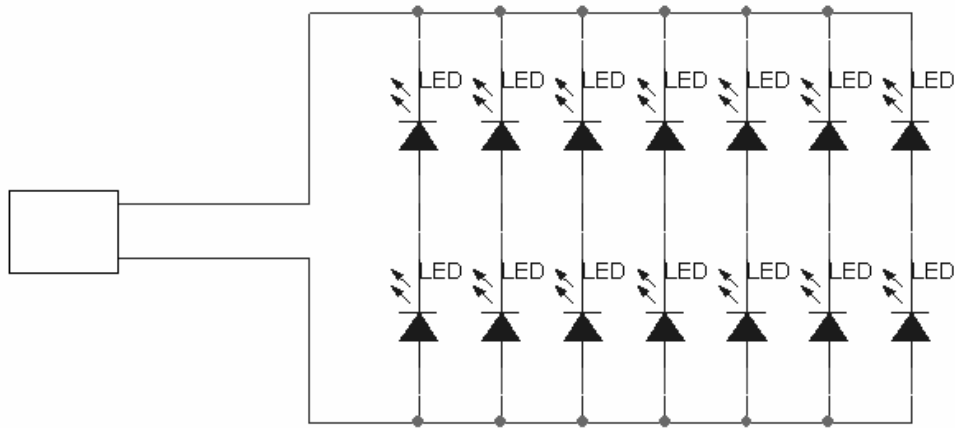

Figure 4.3 LED driver circuit

4.3. Block Diagram

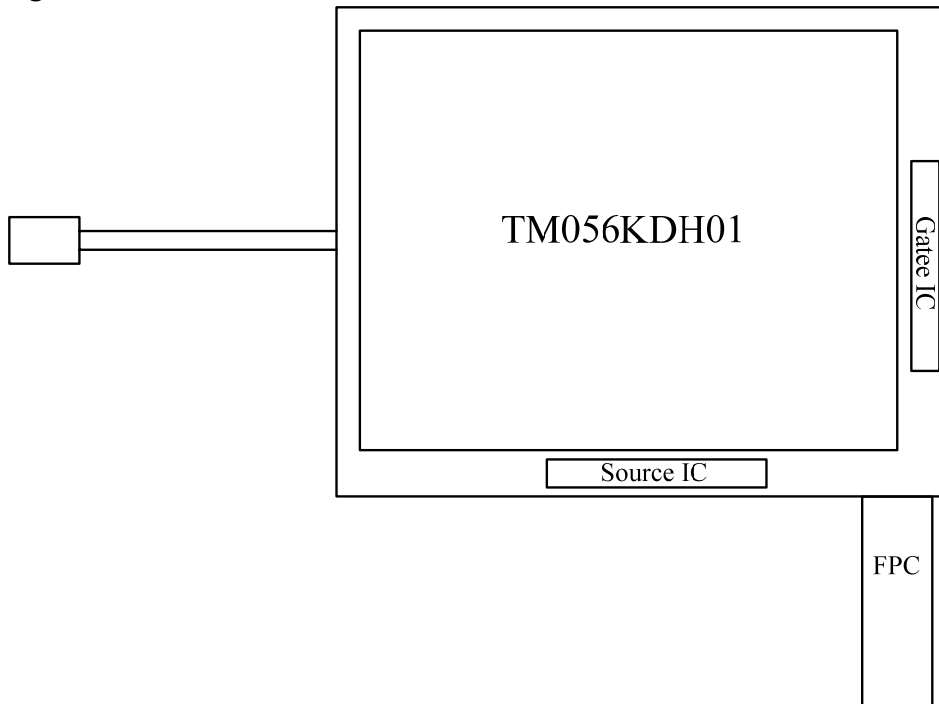

Figure 4.4 LCD module diagram



5 Timing Chart

5.1 Timing Parameter

Parameter	Symbol	Min.	Typ.	Max.	Unit.	Remark
Rising time	t_r	-	-	60	ns	Note 1
Falling time	t_f	-	-	60	ns	Note 1
High and low level pulse width	t_{CPH}	150	154	158	ns	CPH1-3
CPH pulse width	t_{CWH}	40	50	60	%	CPH1-3
CPH pulse delay	t_{C12}	30	$t_{CPH}/3$	$t_{CPH}/2$	ns	CPH1-3
	t_{C23}					
	t_{C31}					
STH setup time	t_{SUH}	20	-	-	ns	STHL/R
STH hold time	t_{HDH}	20	-	-	ns	STHL/R
STH pulse width	t_{STH}	-	1	-	t_{CPH}	STHL/R
STH period	t_H	61.5	63.5	65.5	us	STHL/R
OEH pulse width	t_{OEH}	-	7	-	us	
Sample and hold disable time	t_{DIS1}	-	55	-	us	
OEV pulse width	t_{OEV}	-	27	-	us	
CKV pulse width	t_{CKV}	16	-	40	us	
Clean enable time	t_{DIS2}	-	16	-	us	
Horizontal display time range	t_{DH}	-	960	-	$t_{CPH}/3$	
STV setup time	t_{SUV}	400	-	-	ns	STVD/U
STV hold time	t_{HDV}	400	-	-	ns	STVD/U
STV pulse width	t_{STV}	-	-	1	t_H	STVD/U
Horizontal line per field	t_V	256	262.5	268	t_H	Note 2
Vertical display start	t_{SV}	-	3	-	t_H	
Vertical display range	t_{DV}	-	234	-	t_H	
Vertical start line	t_{SLV}	-	-	21	t_H	
VCOM rising time	t_{rCOM}	-	-	5	us	
VCOM falling time	t_{fCOM}	-	-	5	us	
VCOM delay time	t_{DCOM}	-	-	3	us	
RGB delay time	t_{DRGB}	-	-	1	us	

Note 1: For all of logic signal.

Note 2: Please don't use odd horizontal lines to drive LCD panel for both odd and even field simultaneously.



5.2 Timing Diagram

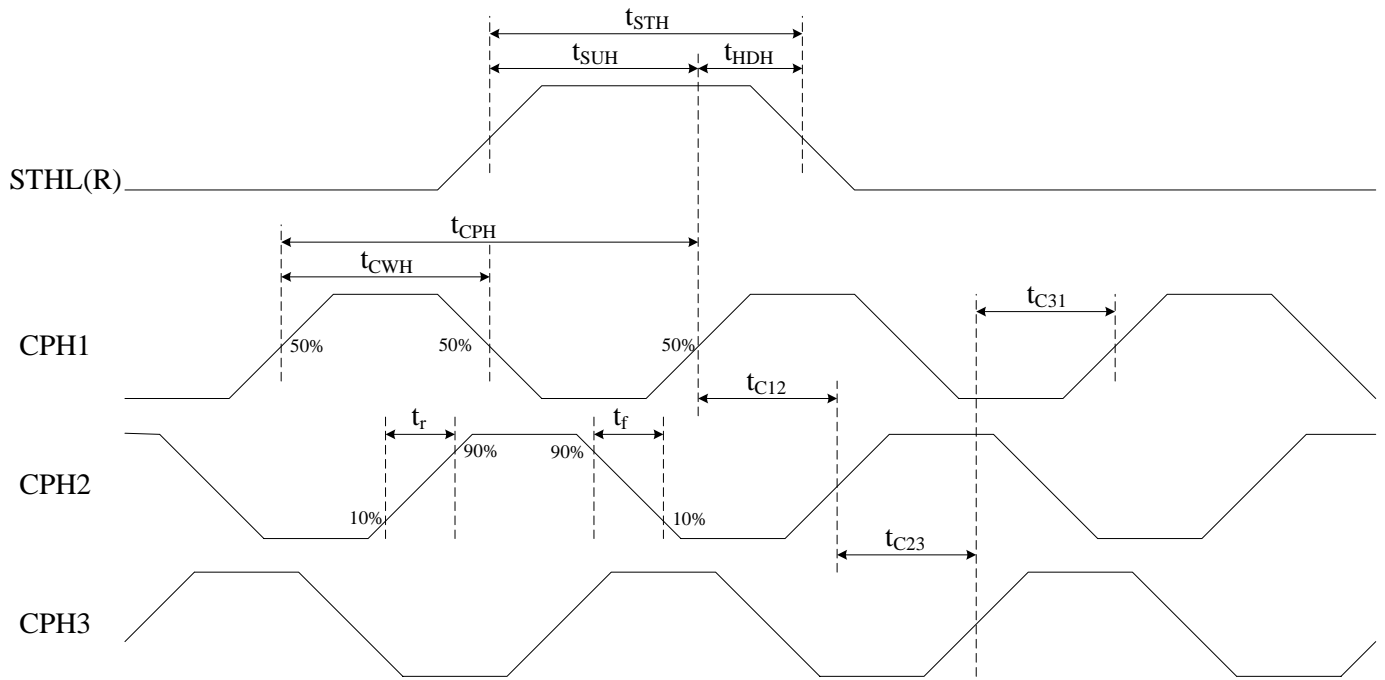

Figure 5.1: sampling clock timing

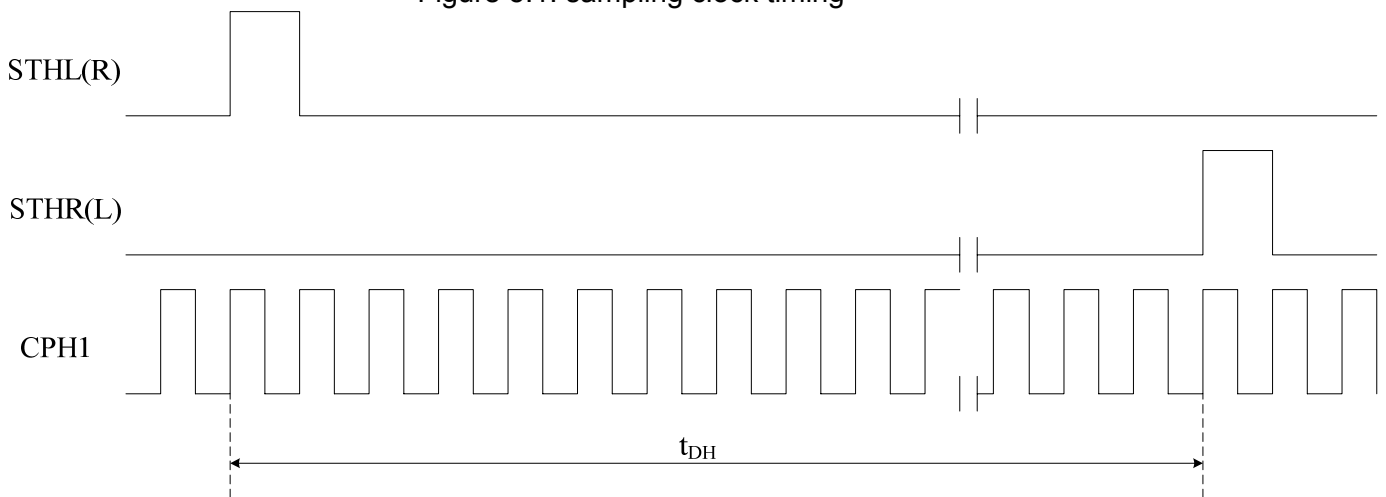

Figure 5.2: horizontal display range timing

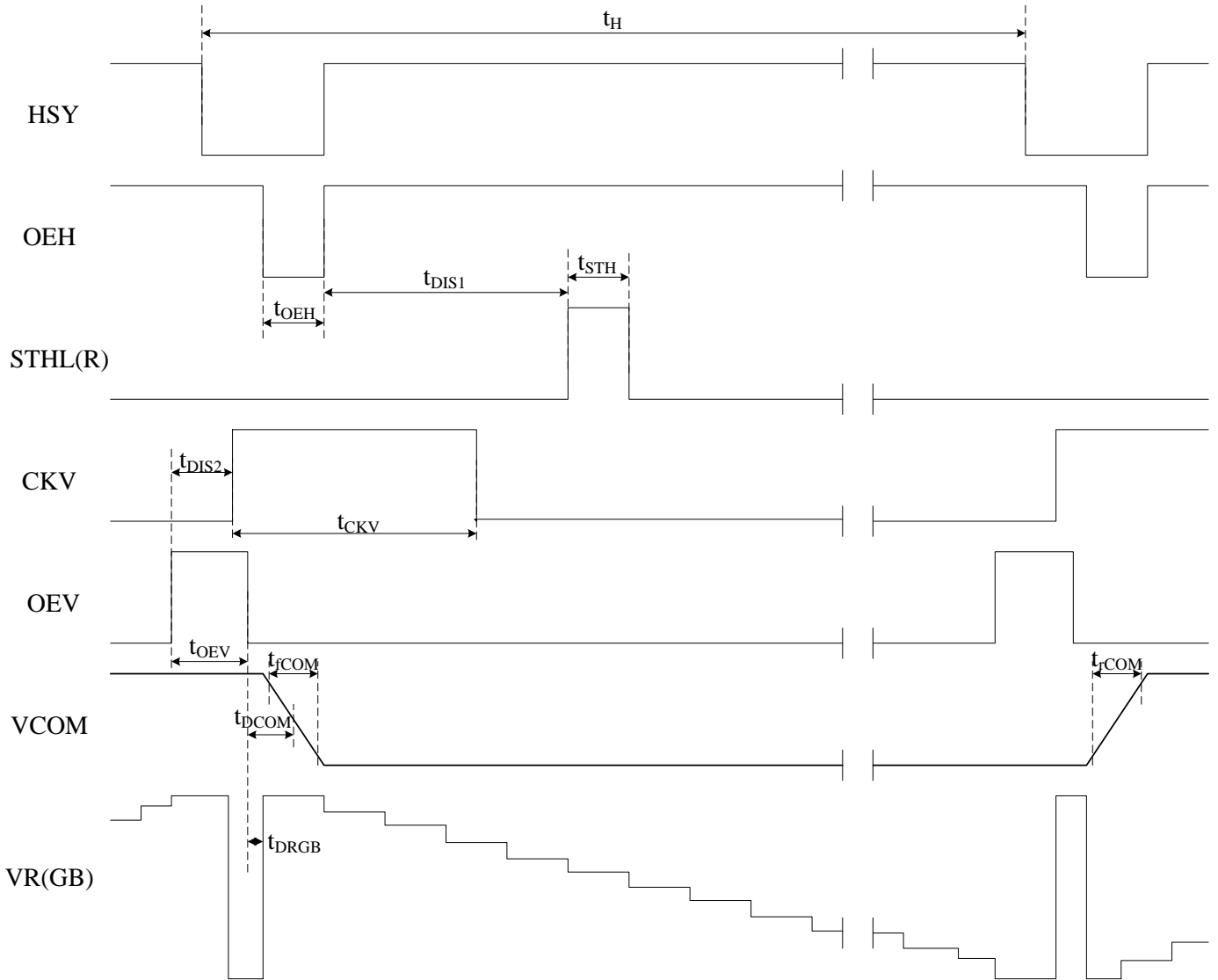

Figure 5.3: horizontal display timing

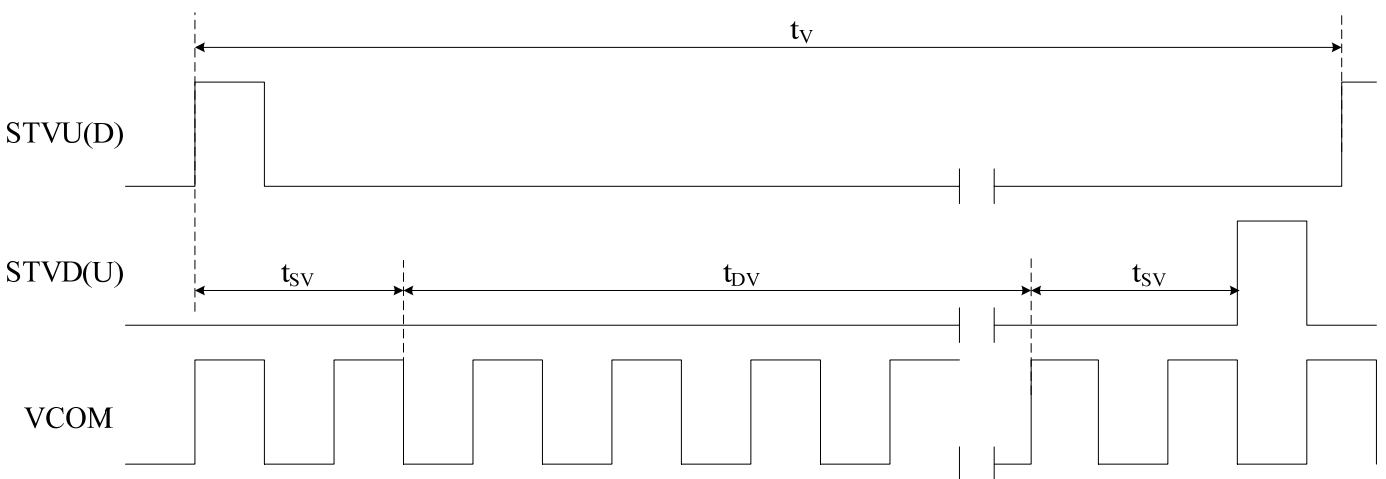

Figure 5.4: vertical display timing

The information contained herein is the exclusive property of SHANGHAI TIANMA MICRO-ELECTRONICS Corporation, and shall not be distributed, reproduced, or disclosed in whole or in part without prior written permission of SHANGHAI TIANMA MICRO-ELECTRONICS Corporation.

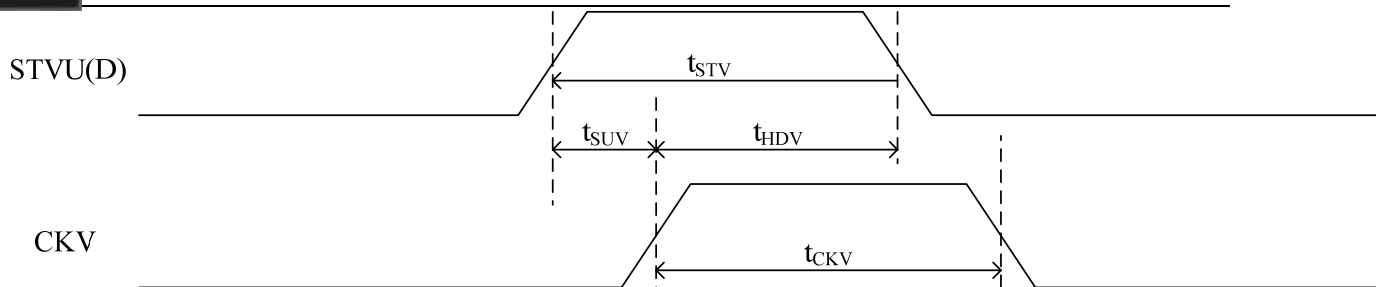

Figure 5.5: vertical shift clock timing

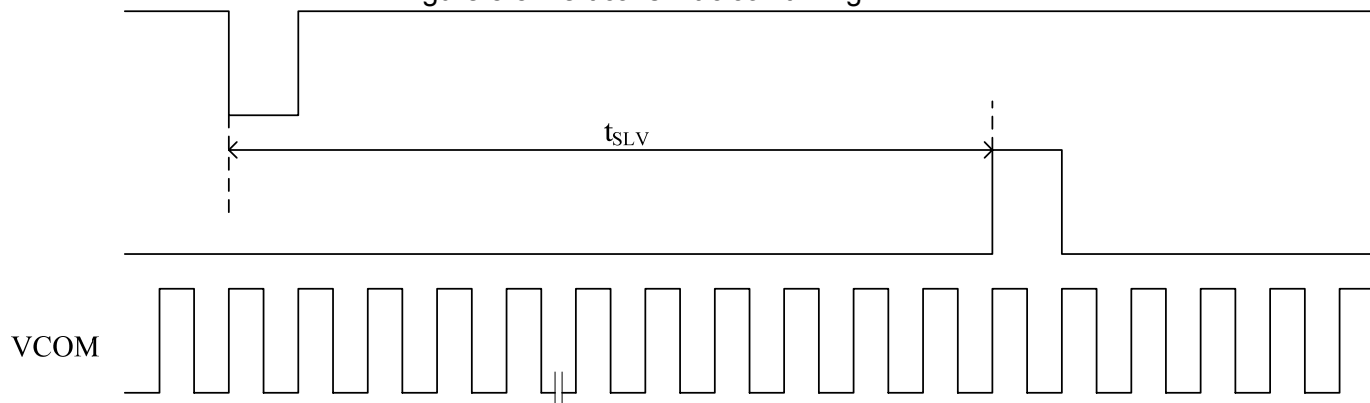

Figure 5.5: vertical start line timing



5.2. Power on/off Sequence

5.2.1 Power on Sequence

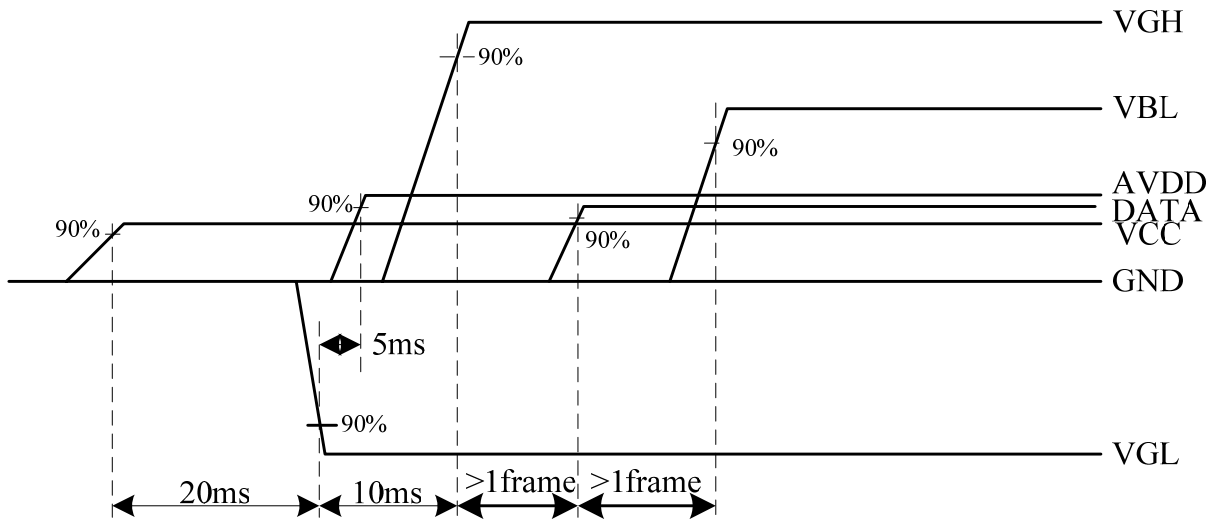

Figure 5.6 Power on sequence

VCC→VGL→AVDD→VGH→DATA→VBL

Note: the interval time should more than the label

5.2.2 Power off Sequence

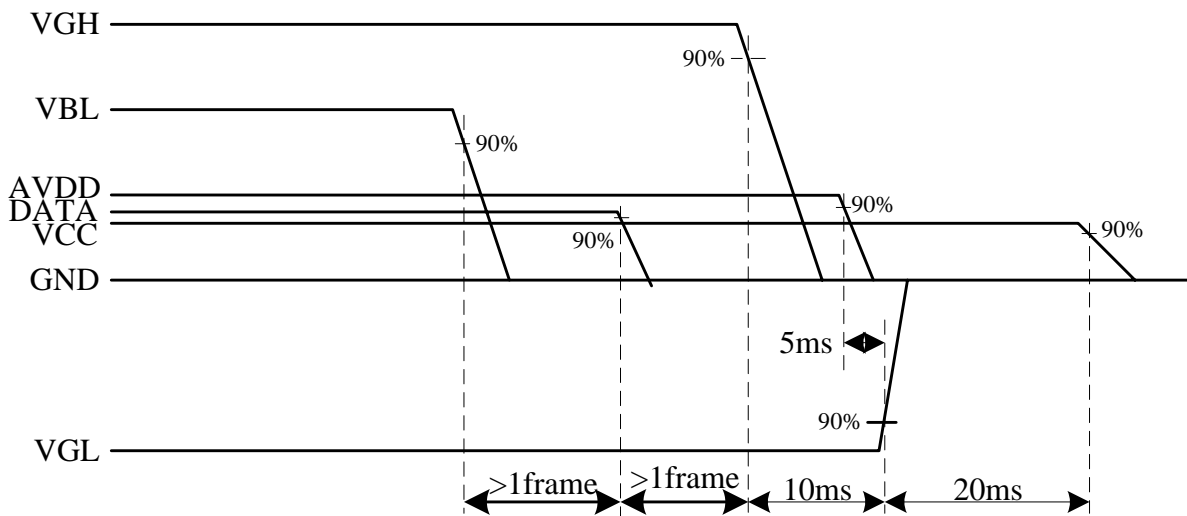

Figure 5.7 Power off sequence

VBL→DATA→VGH→AVDD→VGL→VCC

Note: the interval time should more than the label



6 Optical Characteristics

6.1 Optical Specification

Ta=25°C

Item	Symbol	Condition	Min	Typ.	Max.	Unit	Remark
View Angles	θT	$CR \geq 10$	35	45		Degree	Note 2,3
	θB		55	65			
	θL		55	65			
	θR		55	65			
Contrast Ratio	CR	$\theta = 0^\circ$	200	300			Note 3
Response Time	Ton	25°C		25	50	ms	Note 4
	Toff						
Chromaticity	White	x	Backlight is on	0.260	0.310	0.360	Note 1,5
		y		0.280	0.330	0.380	
	Red	x		0.535	0.585	0.635	
		y		0.292	0.342	0.392	
	Green	x		0.276	0.326	0.376	
		y		0.525	0.575	0.625	
	Blue	x		0.091	0.141	0.191	
		y		0.060	0.110	0.160	
Uniformity	U		70	80		%	Note 6
NTSC			45	50		%	Note 5
Luminance	L		160	200		cd/m ²	Note 7

Test Conditions:

1. The ambient temperature is 25°C. $I_L = 20\text{mA}$
2. The test systems refer to Note 1 and Note 2.



Note 1: Definition of optical measurement system.

The optical characteristics should be measured in dark room. After 5 minutes operation, the optical properties are measured at the center point of the LCD screen. All input terminals LCD panel must be ground when measuring the center area of the panel.

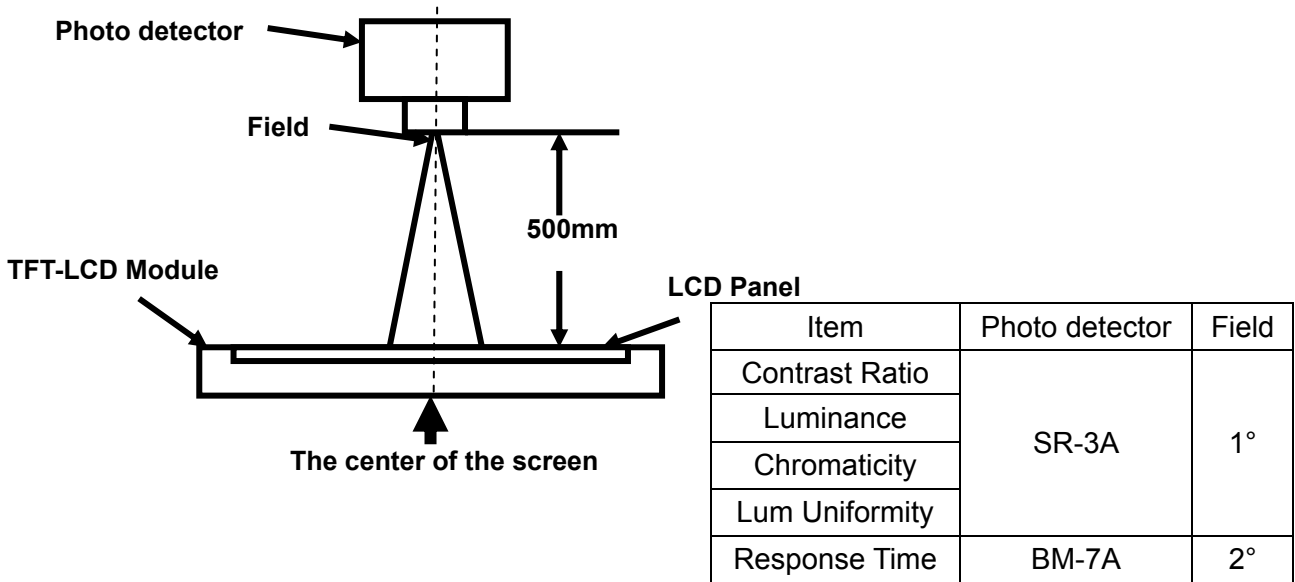

Note 2: Definition of viewing angle range and measurement system.

viewing angle is measured at the center point of the LCD by CONOSCOPE(ergo-80).

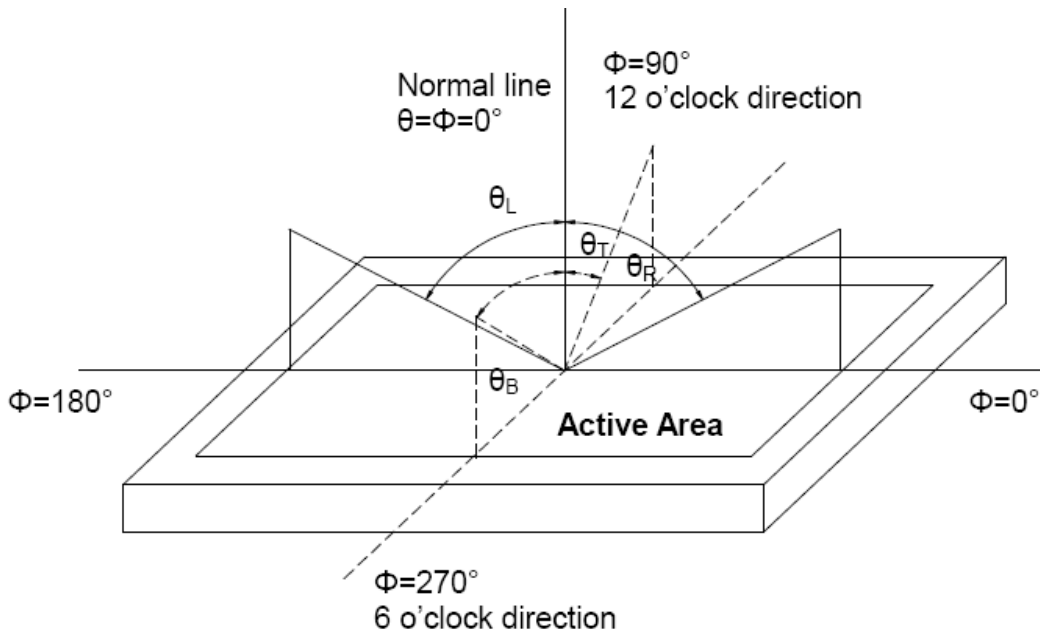

Fig. 6.1 Definition of viewing angle



Note 3: Definition of contrast ratio

$$\text{Contrast ratio (CR)} = \frac{\text{Luminance measured when LCD is on the "White" state}}{\text{Luminance measured when LCD is on the "Black" state}}$$

“White state “:The state is that the LCD should driven by V_{white} .

“Black state”: The state is that the LCD should driven by V_{black} .

V_{white} : To be determined V_{black} : To be determined.

Note 4: Definition of Response time

The response time is defined as the LCD optical switching time interval between “White” state and “Black” state. Rise time (T_{ON}) is the time between photo detector output intensity changed from 90% to 10%. And fall time (T_{OFF}) is the time between photo detector output intensity changed from 10% to 90%.

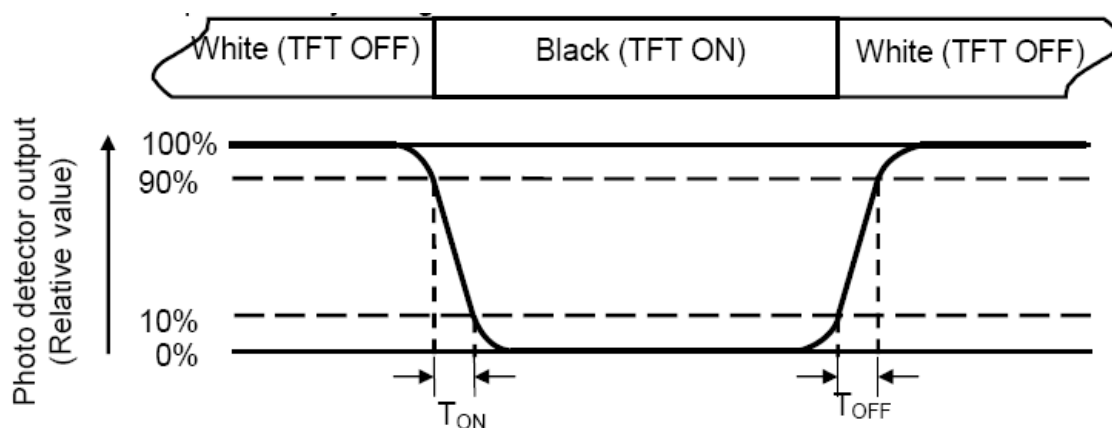

Note 5: Definition of color chromaticity (CIE1931)

Color coordinates measured at center point of LCD.



Note 6: Definition of Luminance Uniformity

Active area is divided into 9 measuring areas (Refer Fig. 2). Every measuring point is placed at the center of each measuring area.

$$\text{Luminance Uniformity}(U) = L_{\min} / L_{\max}$$

L-----Active area length W----- Active area width

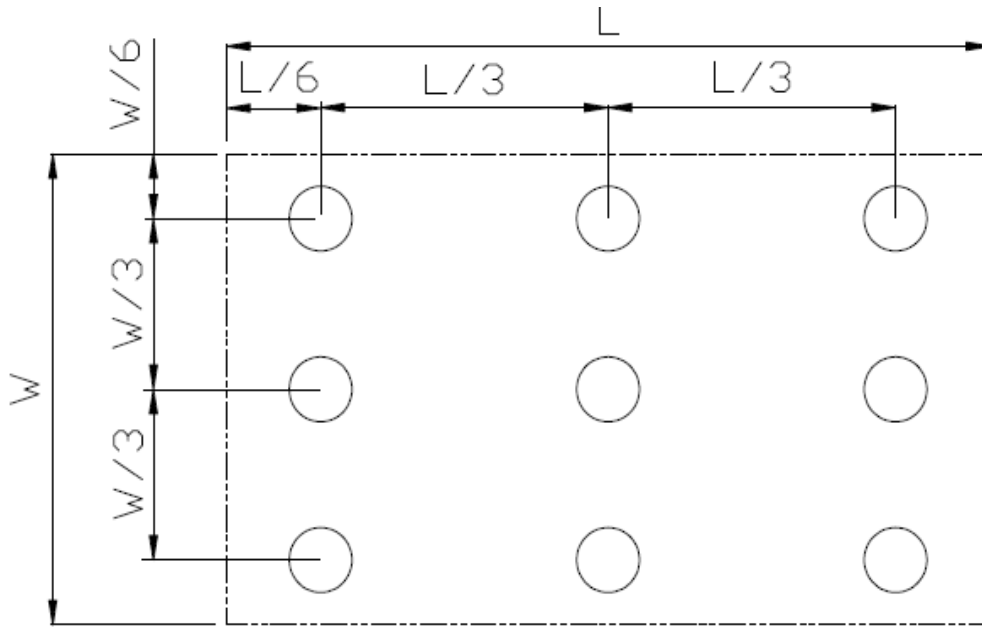

Fig. 6.2 Definition of uniformity

Lmax: The measured maximum luminance of all measurement position.

Lmin: The measured minimum luminance of all measurement position.

Note 7: Definition of Luminance :

Measure the luminance of white state at center point.



7 Environmental / Reliability Test

No	Test Item	Condition	Remarks
1	High Temperature Operation	Ts=+70°C, 240hrs	Note1 IEC60068-2-2,GB2423.2—89
2	Low Temperature Operation	Ta=-20°C, 240hrs	IEC60068-2-1 GB2423.1—89
3	High Temperature Storage (non-operation)	Ta=+80°C, 240hrs	IEC60068-2-2, GB2423.2—89
4	Low Temperature Storage (non-operation)	Ta=-30°C, 240hrs	IEC60068-2-1 GB2423.1—89
5	High Temperature & High Humidity Operation	Ta = +60°C, 90% RH max,240 hours	Note2 IEC60068-2-3, GB/T2423.3—2006
6	Thermal Shock (non-operation)	-30°C 30 min~+80°C 30 min, Change time:5min, 100 Cycle	Start with cold temperature, end with high temperature IEC60068-2-14,GB2423.22—87
7	Electro Static Discharge (operation)	±2KV,Human Body Mode, 100pF/1500Ω	IEC61000-4-2 GB/T17626.2—1998
8	Vibration (non-operation)	Sine Wave Frequency range:10~55Hz, Stroke:1.5mm Sweep:10Hz~55Hz~10Hz 2 hours for each direction of X.Y.Z.(6 hours for total)	IEC60068-2-6 GB/T2423.10—1995
9	Shock (non-operation)	100G 6ms, ±X,±Y,±Z 3times for each direction	IEC60068-2-27 GB/T2423.5—1995
10	Package Drop Test	Height:80 cm, 1 corner, 3 edges, 6 surfaces	IEC60068-2-32 GB/2423.8—1995
11	Package Vibration Test	Random Vibration: 0.015GxG/Hz for 5-200Hz, -6dB/Octave from 200-500Hz 2 hours for each direction of X,Y,Z (6 hours for total)	IEC60068-2-34

Note1: Ts is the temperature of panel's surface.

Note2: Ta is the ambient temperature of samples.



9 Packing Drawing

9.1 Packing Material Table

No	Item	Model (Material)	Dimensions(mm)	Unit Weight (Kg)	Quantity	Remark
1	LCM module	TM056KDH01	126.50x100.00x5.70	0.123	50	including the dimensions of all parts
2	Partition_1	Corrugated Paper	513x333x215	2.000	1	
3	Anti-Static Bag	PE	185x140	0.010	50	Anti-static
4	Dust-Proof Bag	PE	-----	0.060	1	
5	Partition_2	Corrugated Paper	505x332x4.00	0.100	2	
6	Corrugated Bar	Corrugated Paper	513x190x4	0.060	4	
7	Carton	Corrugated Paper	530x350x250	0.940	1	
8	Total weight	10.09±5%				

9.2 Packing Quantity

Total LCM quantity in Carton : no. of partition 2 Rows x quantity per Row 25 = 50



9.3 Packing Drawing

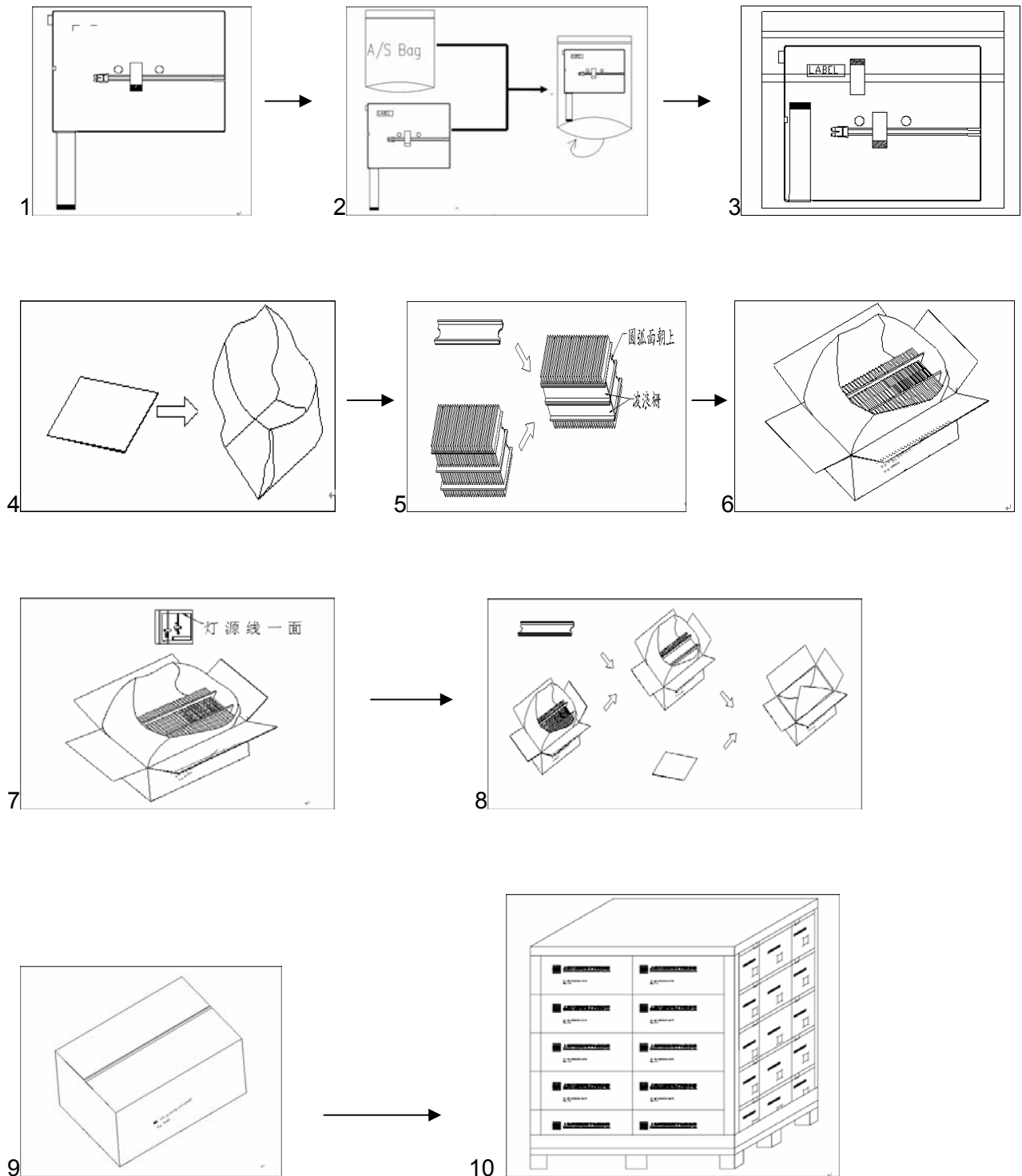



10 Precautions for Use of LCD Modules

10.1 Handling Precautions

- 10.1.1 The display panel is made of glass. Do not subject it to a mechanical shock by dropping it from a high place, etc.
- 10.1.2 If the display panel is damaged and the liquid crystal substance inside it leaks out, be sure not to get any in your mouth, if the substance comes into contact with your skin or clothes, promptly wash it off using soap and water.
- 10.1.3 Do not apply excessive force to the display surface or the adjoining areas since this may cause the color tone to vary.
- 10.1.4 The polarizer covering the display surface of the LCD module is soft and easily scratched. Handle this polarizer carefully.
- 10.1.5 If the display surface is contaminated, breathe on the surface and gently wipe it with a soft dry cloth. If still not completely clear, moisten cloth with one of the following solvents:
 - Isopropyl alcohol
 - Ethyl alcohol
- 10.1.6 Solvents other than those mentioned above may damage the polarizer. Especially, do not use the following:
 - Water
 - Ketone
 - Aromatic solvents
- 10.1.7 Do not attempt to disassemble the LCD Module.
- 10.1.8 If the logic circuit power is off, do not apply the input signals.
- 10.1.9 To prevent destruction of the elements by static electricity, be careful to maintain an optimum work environment.
- 10.2 Be sure to ground the body when handling the LCD Modules.
- 10.3 Tools required for assembly, such as soldering irons, must be properly ground.
- 10.4 To reduce the amount of static electricity generated, do not conduct assembly and other work under dry conditions.
- 10.5 The LCD Module is coated with a film to protect the display surface. Be care when peeling off this protective film since static electricity may be generated.
- 10.6 Storage precautions
 - 10.6.1 When storing the LCD modules, avoid exposure to direct sunlight or to the light of fluorescent lamps.
 - 10.6.2 The LCD modules should be stored under the storage temperature range. If the LCD modules will be stored for a long time, the recommend condition is:
- 10.7 Temperature : 0°C ~ 40°C Relatively humidity: ≤80%
 - 10.7.1 The LCD modules should be stored in the room without acid, alkali and harmful gas.
 - 10.7.2 Transportation Precautions
- 10.8 The LCD modules should be no falling and violent shocking during transportation, and also should avoid excessive press, water, damp and sunshine.